



Universal holder for sugarcube cameras

Datasheet

6202500119001_ds_CamHolder_EN_r01

4/2022

atesystem 
FOCUSED ON **DETAIL**

ATEsystem s.r.o.
Studentska 6202/17
708 00 Ostrava-Poruba
Czech Republic

M +420 595 172 720
E atesystem@atesystem.cz
W www.atesystem.cz

OBSAH

1 KEY FEATURES..... 4

2 PRODUCT DESCRIPTION 4

3 MOUNTING DRAWINGS 5

4 PRODUCT OPTIONS..... 6

1 KEY FEATURES

- Universal for many camera types.
 - Basler Ace, Basler Ace2, FLIR, IDSAVT-MAKRO, Opto-Engineering cameras - COE, LUCID, JAI GO.



Fig. 1 – Universal holder with mounted camera Basler ace2

2 PRODUCT DESCRIPTION

The camera holder consists of one aluminum part. Holder is equipped with two types of threads (M8, UNC20) for montage. The surface finish of all parts is black matt anodized, which increases scratch resistance.

Parameter	Value
Dimensions without mounting rod	53,6 x 39 x 51 mm
Mounting rod length x diameter	30 x 12 mm
Camera front dimensions	29 x 29 mm
Weight	107 g
Types of threads	M8, 1/4"

Tab. 1 – Heat sink parameters

Universal camera holder for sugarcube cameras is designed to be easily used with the standard Balluff fastening system. For this purpose, 12 mm diameter mounting rod is used, which fits perfectly into the fasteners.

3 MOUNTING DRAWINGS

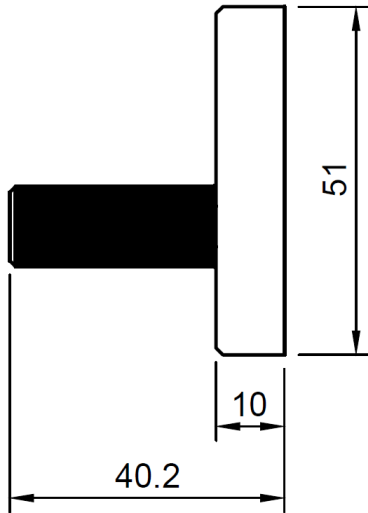

Side view:

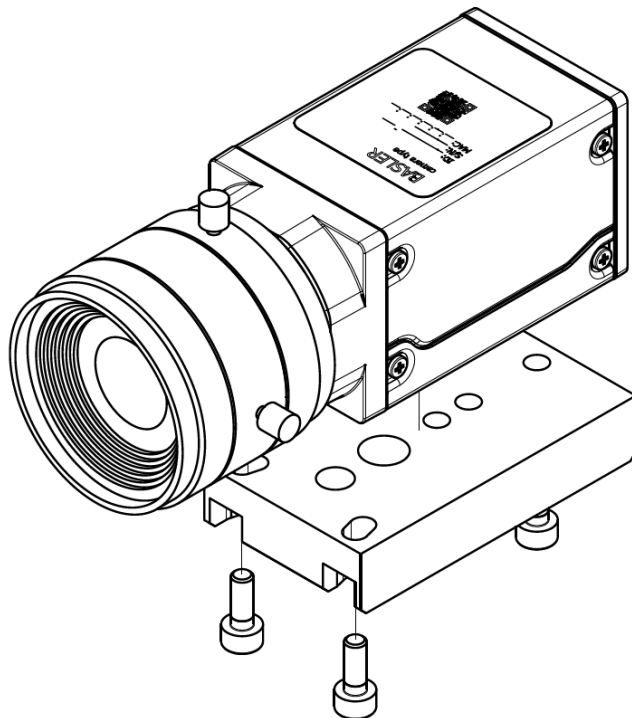
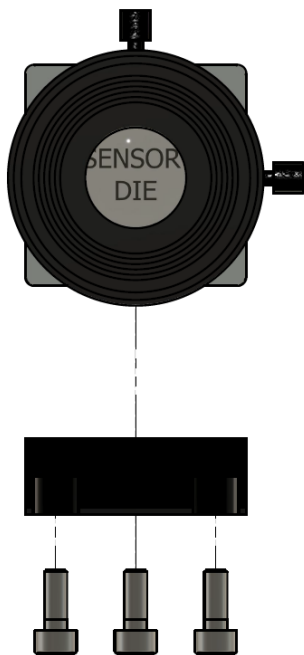
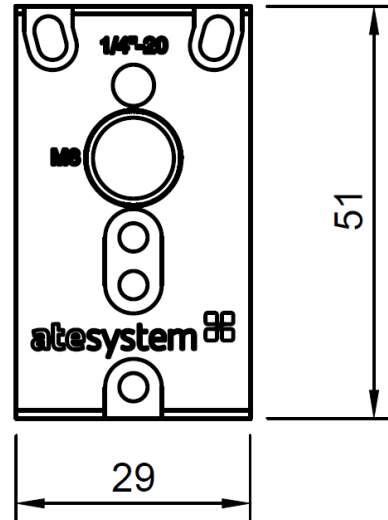

Bottom view:



4 PRODUCT OPTIONS

Order number	Description	
62025003	Universal cameras heat sink Package: 2x side heatsink, 1x holder, 4x M4x10, 3x M3x8	
62025001	Universal cameras holder Package: 1x holder, 3x M3x8	
62025004	Rod for holder M8 D12x40mm	



**Fig. 4 – Left: Front view of the holder without camera,
 Right: View of holder from below without camera**



**Fig. 5 – Left: Holder with mounted camera ace USB3,
Right: Holder with mounted camera ace Gige**



**Fig. 6 – Left: Holder with mounted camera ace2 USB3,
Right: Holder with mounted camera ace2 Gige**

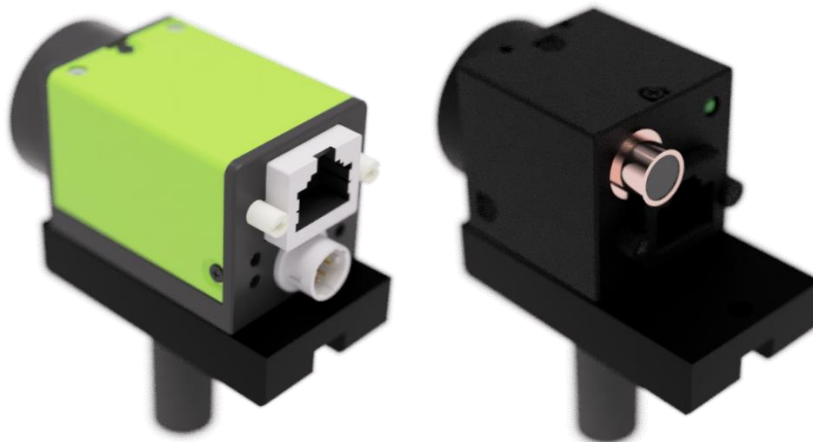

**Fig. 7 – Left: Holder with mounted camera JAI,
Right: Holder with mounted camera FLIR**