



# Universal heat sink for sugarcube cameras

## Datasheet

12/2025

**atesystem**   
FOCUSED ON **DETAIL**

---

**ATEsystem s.r.o.**  
Technologická 378/9  
708 00 Ostrava-Pustkovec  
Czech Republic

**T** +420 595 172 720  
**E** [atesystem@atesystem.cz](mailto:atesystem@atesystem.cz)  
**W** [www.atesystem.cz](http://www.atesystem.cz)



---

**OBSAH**

---

**1 KEY FEATURES..... 4**

**2 PRODUCT DESCRIPTION ..... 4**

**3 MOUNTING DRAWINGS..... 5**

**4 COOLING EFFICIENCY ..... 6**

    4.1 *THERMAL NOISE EXAMPLES* ..... 6

**5 PRODUCT OPTIONS..... 7**

---

## KEY FEATURES

- Universal for many cameras types.
  - Basler ace, Basler ace2, FLIR, IDSAVT-MAKRO, Opto-Engineering cameras - COE, LUCID, JAI GO.
- Reduces working temperature up to 10 °C.
- Improves image quality by reducing thermal noise.
- Extends camera life and improves overall performance.
- Holder without heat sink can be used if there is only limited space available.

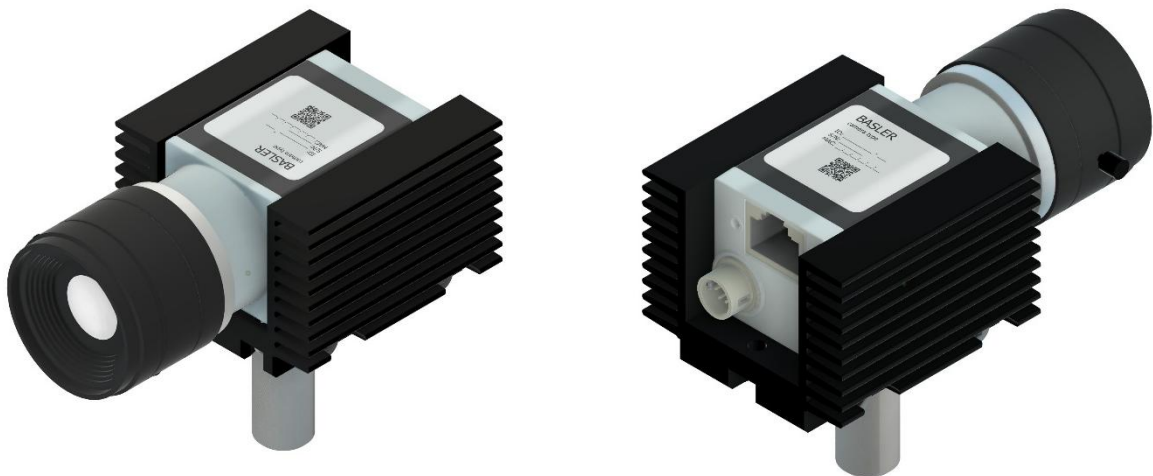

Fig. 1 – Universal heat sink with mounted camera Basler

## 1 PRODUCT DESCRIPTION

The camera holder with heat sink consists of four aluminum parts, which are fastened together by screw connections. The heat sinks side panels have milled ribs to maximize the cooling surface. Thanks to oversize, the heat sink is also suitable for PoE cameras that are characterized by higher power dissipation. The surface finish of all parts is black matt anodized, which increases scratch resistance while improving cooling efficiency by radiating heat to the surrounding area.

Parameter	Value
Dimensions without mounting rod	51,2 x 39 x 51 mm
Mounting rod length x diameter	30 x 12 mm
Camera front dimensions	29 x 29 mm
Weight	100 g
Types of threads	M8, 1/4"

Tab. 1 – Heat sink parameters

Universal camera heat sink for sugarcube cameras is designed to be easily used with the standard Balluff fastening system. For this purpose, 12 mm diameter mounting rod is used, which fits perfectly into the fasteners (The rod for the camera holder is not part of the package, it can be purchased as an accessory under order number 62025004).

## 2 MOUNTING DRAWINGS

Side view:

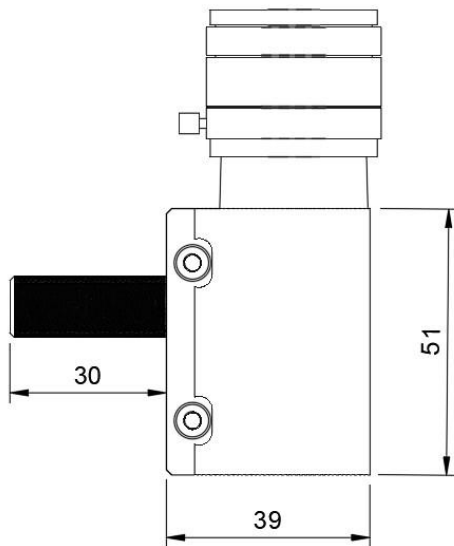

Bottom view:

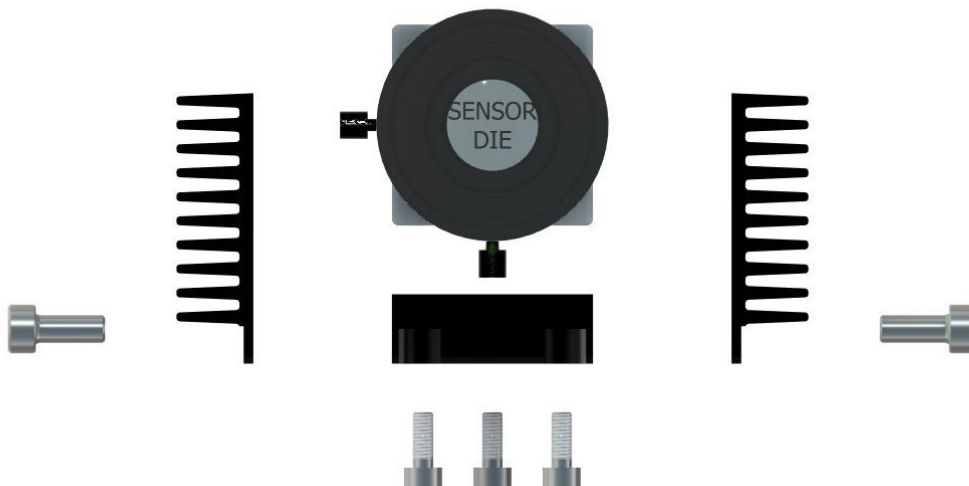
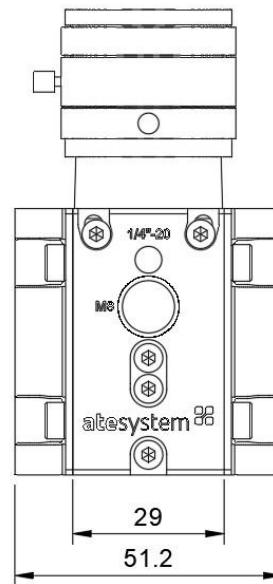

### 3 COOLING EFFICIENCY

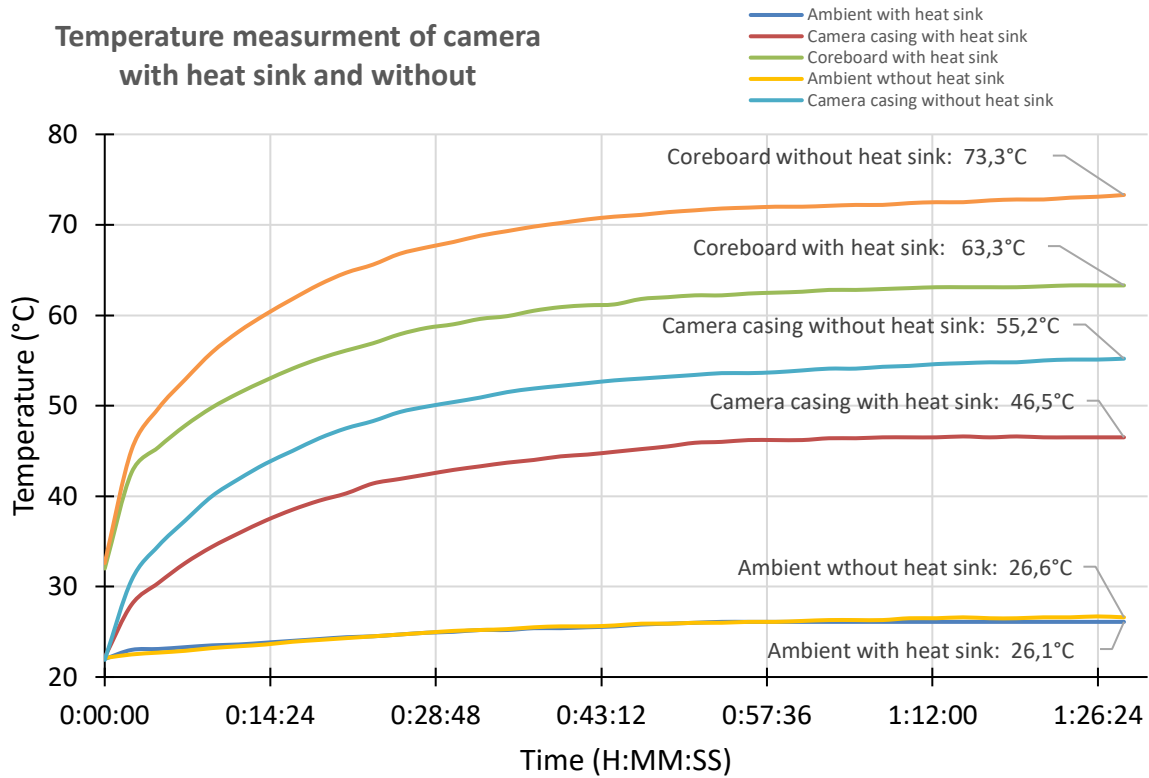
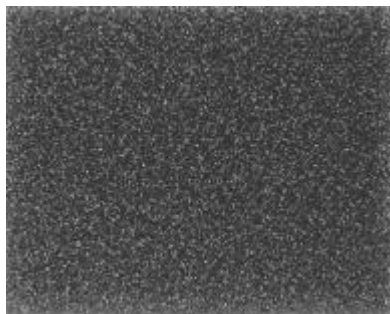

**Fig. 2 – Temperature graph of a2A1920-51gcPRO**

The graph in Fig. 2 shows the temperature rise in time and the operating temperature of the camera after 1,5 hour. Measurements were performed on cameras powered by 12V source with mounted objective. The ambient temperature during measurement was 25 °C. Temperature values was readed from the camera's internal sensor.

#### 3.1 THERMAL NOISE EXAMPLES

Camera image without heat sink,  
 camera temperature 70,4 °C



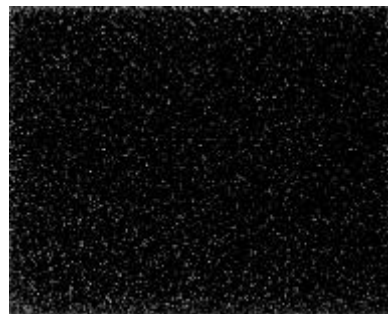

Camera image with heat sink,  
 camera temperature 62,3 °C



**Used set:** Camera Basler a2A1920-51gcPRO 50gm (CMOS), exposure time 10 s, maximum gain, after operating 1 hour at ambient temperature 25 °C.

#### 4 PRODUCT OPTIONS

Order number	Description	Image
62025007	<b>Universal camera heat sink</b> Package: 2x side heatsink, 1x holder, 4x M4x10, 3x M3x8	
62025001	<b>Universal camera holder</b> Package: 1x holder, 3x M3x8	
62025004	<b>Rod for holder M8 D12x40mm</b>	

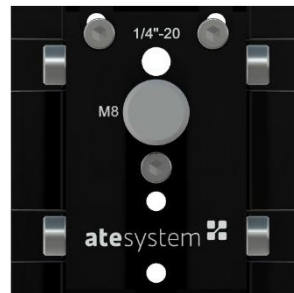
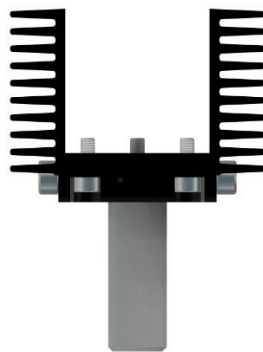

Fig. 3 – Left: Front view of the heat sink without camera,  
 Right: View of the heat sink from below without camera



**Fig. 4 – Heat sink with mounted camera Basler ace USB3**



**Fig. 5 – Heat sink with mounted camera Basler ace GiGE**

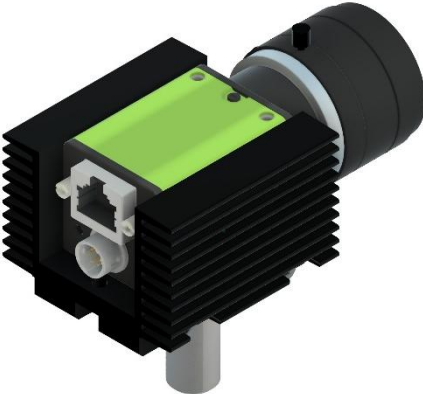

**Fig. 6 – Heat sink with mounted camera JAI**

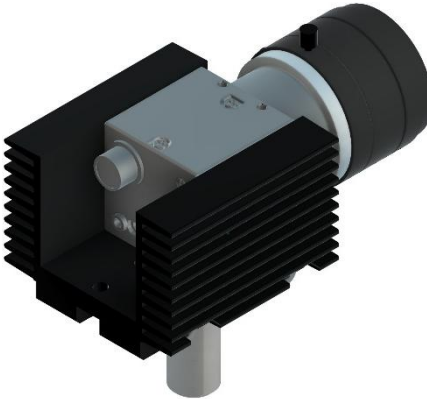

**Fig. 7 – Heat sink with mounted camera FLIR**